

# SAXDOR 400

GTO & GTC



3.1.2025 Helsinki



# VACUUM INFUSED HULL - GELCOAT RAL 9010 (WHITE)

Standard



# POWER SLIDING GRP ROOF

Standard



# SHOEBOX INTEGRATED AFT DECK (DRAINED)

Standard



# WINDSCREEN WIPERS AND CUP HOLDERS

Standard



# ELECTRICALLY OPERATED FOLDABLE TERRACES ON BOTH SIDES (ALMOST 4 METERS LONG)

Standard



# 9" SIMRAD GO DISPLAY WITH SAXDOR CUSTOM USER INTERFACE FOR MONITORING ONBOARD SYSTEMS

Standard

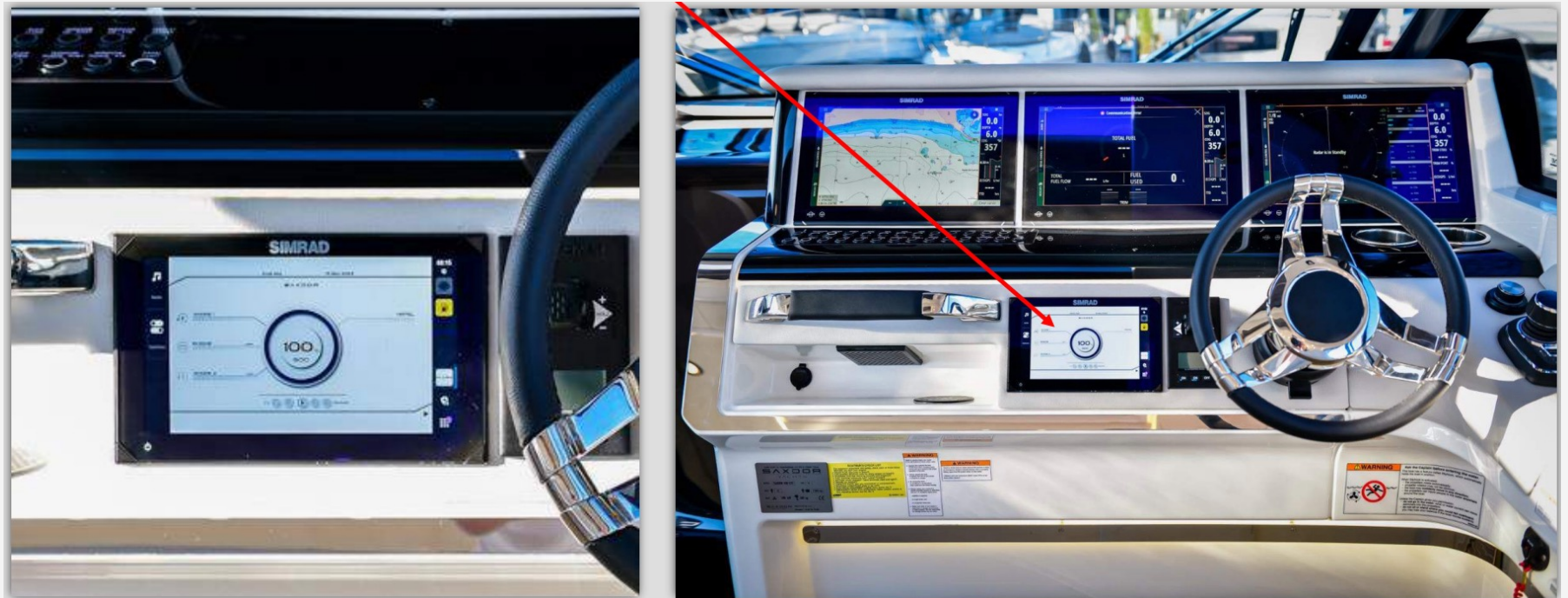

# 16" SIMRAD NSO 16" MAIN NAVIGATION MFD

Standard



# P79 SIMRAD ECHO SOUNDER SYSTEM

Standard

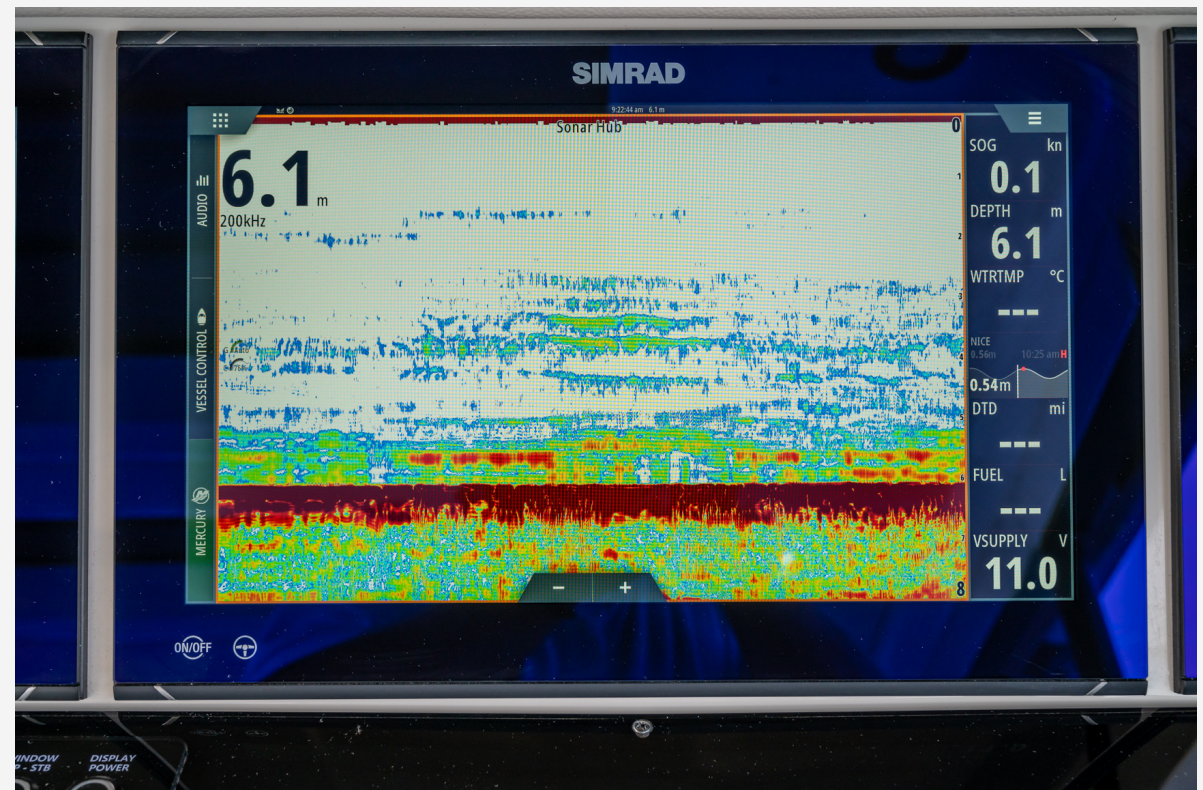

# FULLY INTEGRATED SYSTEMS; ELECTRICAL SYSTEM, ENGINES AND FLUID TANKS ETC. AUDIO WHEN SELECTED

Standard

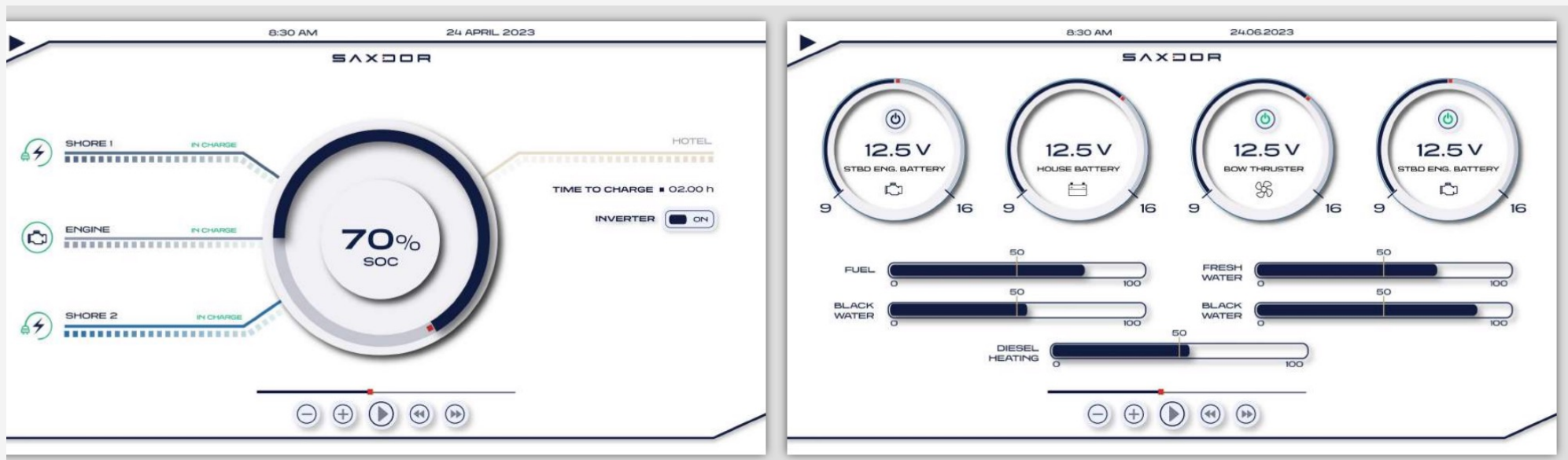

# FULLY INTEGRATED SYSTEMS; ELECTRICAL SYSTEM, ENGINES AND FLUID TANKS ETC. AUDIO WHEN SELECTED

Standard

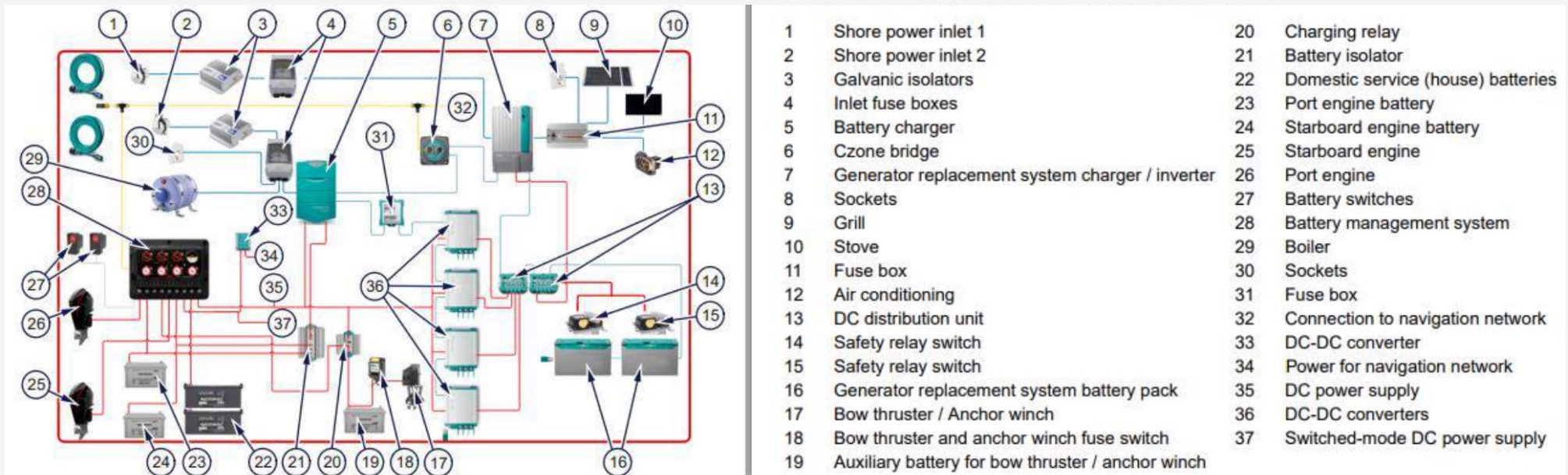

# SHORE POWER - WITH BATTERY CHARGER SHORE POWER CABLE

Standard



# AC OUTLETS: WHEELHOUSE, FRONT CABIN AND TOILET

Standard



# DC AND USB OUTLETS IN WHEELHOUSE AND FRONT CABIN

Standard



# 8 MOORING CLEATS

Standard



# BOW THRUSTER

Standard



# ZIP-WAKE INTERCEPTOR SYSTEM (AUTOMATIC TRIM TABS)

Standard



# MERCURY ACTIVE TRIM

## Standard

Active Trim's intuitive hands-free automation continuously adjusts the engine trim angle to improve performance, fuel economy and ease of driving.



# MERCURY SMARTCRAFT CONNECT

Standard

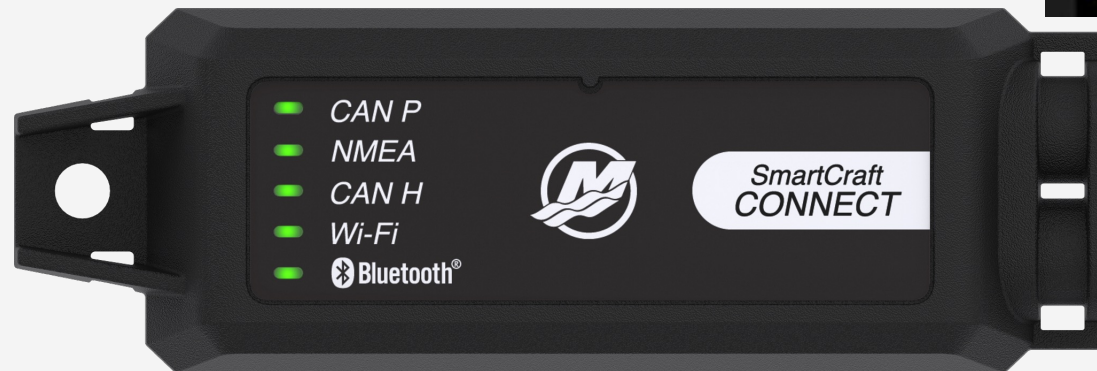

# SLEEPING CABIN IN THE BOW

Standard



# FRESH WATER SYSTEM INCLUDING 40 LITRES HOT WATER BOILER AND AFT DECK SHOWER

Standard



# BATHROOM WITH ELECTRIC TOILET AND SHOWER

Standard



# BLACK WATER TANK WITH ELECTRICAL OVER BORD DISCHARGE & DECK VACUUM OUTLET

Standard



# ELECTRIC TABLE IN WHEELHOUSE

Standard



# GALLEY MODULE INCLUDING SINK AND REFRIGERATOR WITH FREEZER BOX

Standard (stove is additional option)

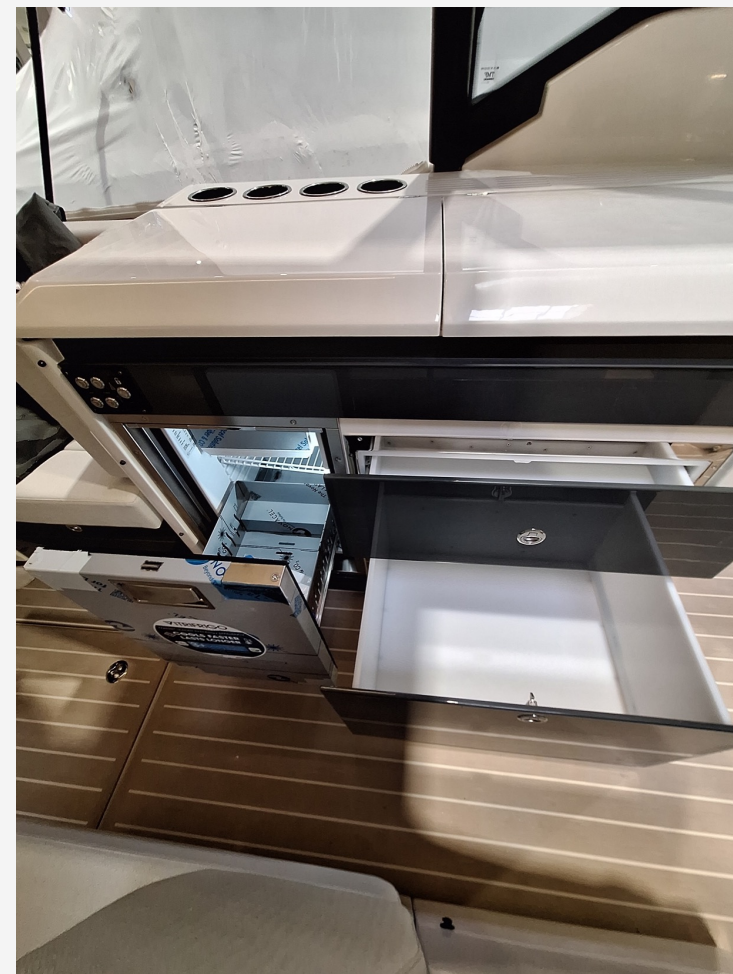

# FLEXITEEK IN SHOWER

Standard



**SAXDOR 400GTO/GTC  
WITH ENGINES: 2 X  
MERCURY V10-350  
BLACK - JPO**

SX400GTO-E-002

SX400GTC-E-002



**SAXDOR 400GTO/GTC  
WITH ENGINES: 2 X  
MERCURY V10-400  
BLACK - JPO**

SX400GTO-E-003

SX400GTC-E-003



# SAXDOR 400GTO/GTC WITH ENGINES: WHITE ENGINE OPTION AVAILABLE WITH ALL ENGINE CONFIGURATIONS

SX400GTO-E-004

SX400GTC-E-004



# SX400GTO/GTC UPHOLSTERY COLORS: MARBLE (LIGHT GREY FABRIC)

Standard

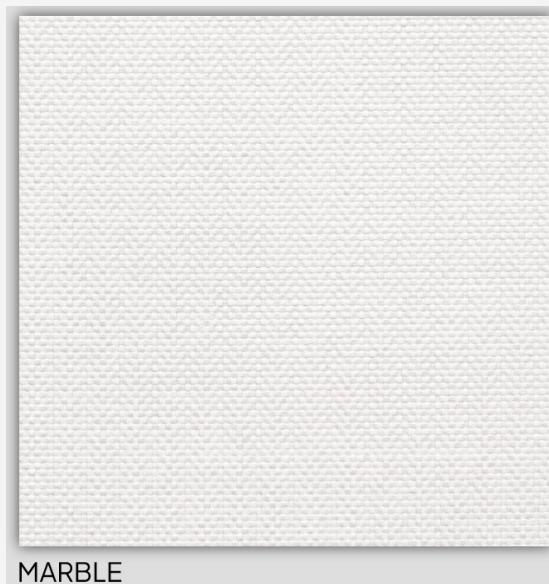

# SX400GTO/GTC UPHOLSTERY COLORS: FLORIDA BLUE (FABRIC VINYL)

SX400GTO-C-001

SX400GTC-C-001

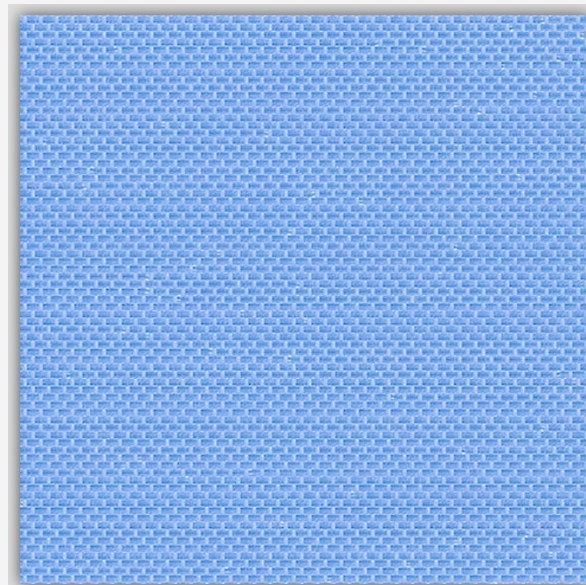

FLORIDA BLUE



# SX400GTO/GTC UPHOLSTERY COLORS: NOUGAT (FABRIC VINYL)

SX400GTO-C-002

SX400GTC-C-002

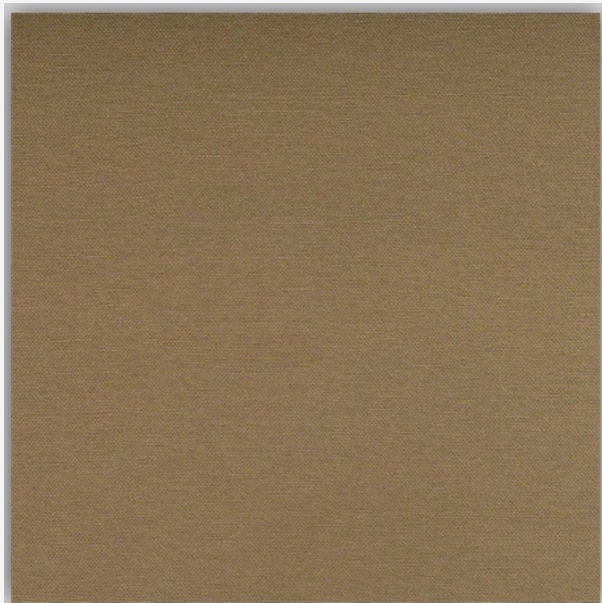

NOUGAT



# SX400GTO/GTC UPHOLSTERY COLORS: COGNAC SHOT (LEATHER LIKE VINYL)

SX400GTO-C-005

SX400GTC-C-006

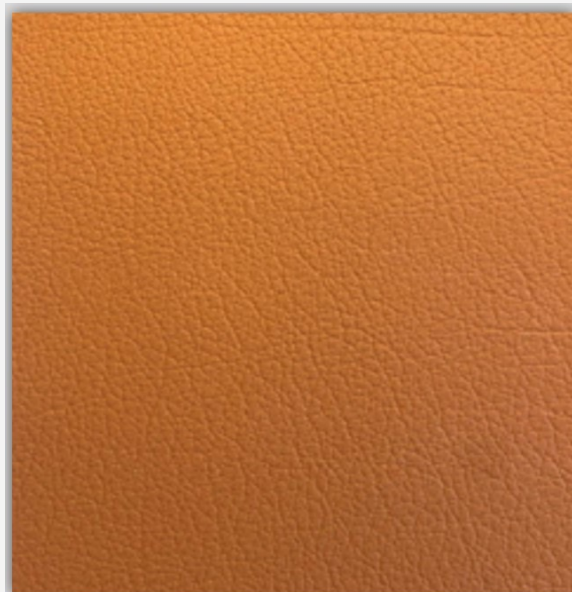

COGNAC SHOT

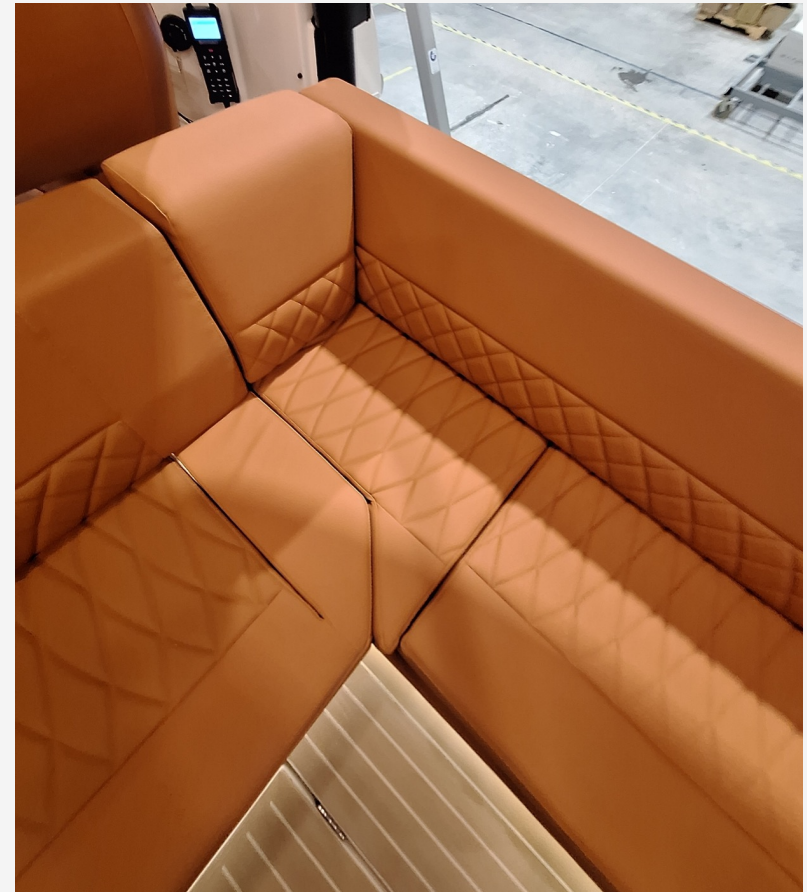

# **SX400GTO/GTC UPHOLSTERY COLORS: HONEY**

SX400GTO-C-006

SX400GTC-C-007

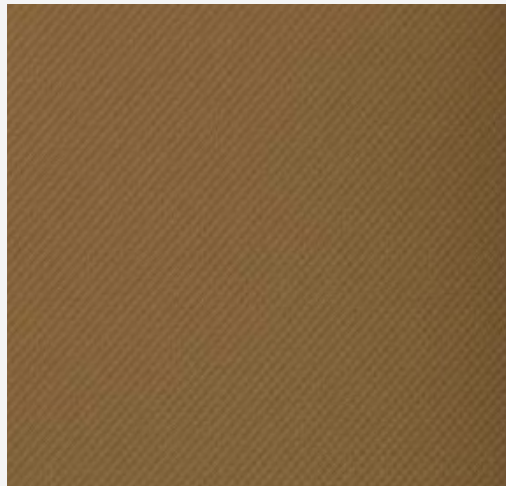

# **SX400GTC (GTC ONLY) UPHOLSTERY COLORS: CREAM AND BRONZE**

SX400GTC-C-005



**SX400GTO/GTC  
GELCOAT HULL  
COLORS: PURE WHITE  
RAL9010**



**SX400GTO/GTC  
GELCOAT HULL  
COLORS: FLORIDA  
BLUE**



SX400GTO-C-003  
SX400GTC-C-003



**SX400GTO/GTC  
GELCOAT HULL  
COLORS: STORM GREY**



SX400GTO-C-004

SX400GTC-C-004



# SX400GTO/GTC GELCOAT HULL COLORS: DARK GREY CONSOLE (RAL 7043)

SX400GTO-O-003

SX400GTC-O-003

(Same as C-pillars, wings on  
the roof, drawers in kitchen)



# SAXDOR 400GTO/GTC WITH ENGINES: MERCURY TECHNOLOGY PACKAGE – ADVANCED JPO FOR MERCURY V10

SX400GTO-P-001

SX400GTC-P-001

Integrates with Sleipner  
Proportional bow thruster,  
upgrade from ON/OFF bow  
thruster. This package is only  
available with V10 engines.



# NAVIGATION PACKAGES: UPGRADED NAVIGATION PACKAGE

SX400GTO-N-001

SX400GTC-N-001

- One additional Simrad NSO16" (two altogether)
- Simrad OP-50 remote
- Simrad HALO20+ Radar
- GPS-compass
- Simrad RS100-B VHF/AIS



# NAVIGATION PACKAGES: ADVANCED NAVIGATION PACKAGE

SX400GTO-N-002

SX400GTC-N-002

- Two additional Simrad NSO16” (three altogether)
- Simrad OP-50 remote
- Simrad HALO24 Radar
- GPS-compass
- Simrad RS100-B VHF/AIS
- Upgraded Echo Sounder sensor with chirp and water temp



# DIESEL HEATING PACKAGE: DIESEL HEATER AND STOVE

SX400GTO-P-008

SX400GTC-P-008

Diesel tank (25L)

(Cannot be combined with  
Aircondition package and/or  
electric stove)



# AIRCONDITION PACKAGE – 8K BTU, CABINS (GTC ALSO IN WHEELHOUSE) – EU 240 VOLT\*

SX400GTO-P-003

SX400GTC-P-003

(Generator replacement package needed  
for off-grid use)

See the difference between GTO/GTC on  
page 92-93



# SAXDOR LIFESTYLE PACKAGE

SX400GTO-P-019

SX400GTC-P-019

- 4x life jackets 40-150 kg
- Saxdor weekend bag
- Mooring package
  - 6 x fenders
  - 6 x fender covers (black)
  - 6 x fender lines (6mm x 1,5m)
  - 6 x mooring lines (16mm/12M)
  - 7,5 kg anchor
  - Anchor line (40m)

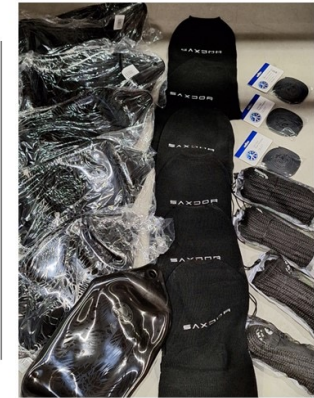

## ELECTRICAL OPTIONS: TWO X LITHIUM BATTERIES EU – 12 KW

SX400GTO-P-006

SX400GTC-P-006

240 volt Generator replacement Package –  
12 kw battery capacity

(Only available with v10 engine version)



## ELECTRICAL OPTIONS: FOUR X LITHIUM BATTERIES EU - 24 KW

SX400GTO-P-007

SX400GTC-P-007

240 volt Generator replacement Package -  
24 kw battery capacity

(Only available with v10 engine version)



# BATTERY PACKAGE: 2 X STARTER OPTIMA 1000 MCA, 2 X DOMESTIC 140 AH GEL & 1 X BOW THRUSTER OPTIMA 1125 MCA

SX400GTO-P-021

SX400GTC-P-021



# TECHNOLOGY: BOW WINDLASS WITH 16 KG SS ULTRA ANCHOR

SX400GTO-P-002

SX400GTC-P-002

40 meter 12 mm rope and 10 meter 7 mm  
chain



# TECHNOLOGY: SEAKEEPER 3

SX400GTO-P-020

SX400GTC-P-020

(12 or 24 kwh Generator replacement  
package required)

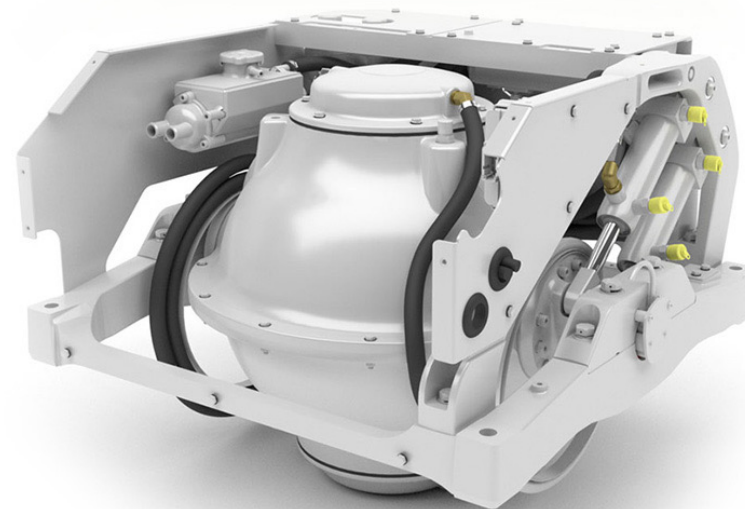

# TECHNOLOGY: UNDERWATER LIGHTS

SX400GTO-P-001

SX400GTC-P-001



## TECHNOLOGY: LIGHTBAR ON ROOF

SX400GTO-P-002

SX400GTC-P-002



# TECHNOLOGY: NIGHT VISION THERMAL CAMERA

SX400GTO-P-003

SX400GTC-P-003

Omnisense Micro-s integrated to Simrad



## TECHNOLOGY: GREY WATER TANK (105L)

SX400GTO-P-020

SX400GTC-P-020

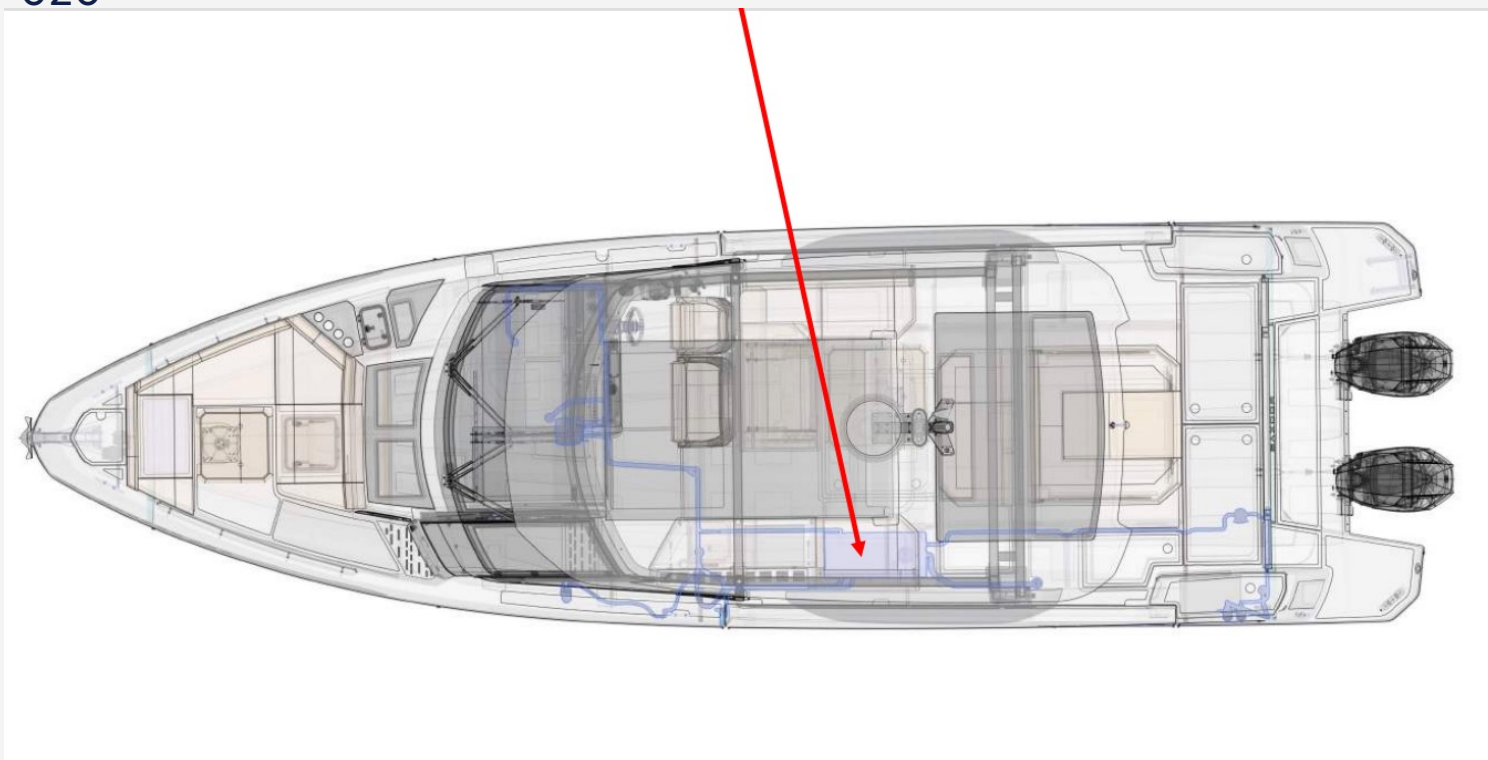

## AUDIO: BASIC AUDIO SYSTEM

SX400GTO-A-001

SX400GTC-A-001

- 4 x Clarion CMSP-651RGB-SWG – speakers
- 2 x Clarion CMSP-651-SWG – speakers
- Clarion XC2410 - 4 Ch. Class D Full-Range Marine Amplifier, 300 W



## AUDIO: ADVANCED AUDIO PACKAGE

SX400GTO-A-002

SX400GTC-A-002

- 2 x JL Audio Speaker 7.7" white M6-770X-C-GwGw
- 2 x JL Audio O-C1-650-F-Sw - internal speaker
- JL Audio M6-650X-L-GwSw-Single
- 2 x JL Audio Speaker 7.7" biały M6-770X-L-GwGw-Single
- JL Audio Subwoofer 8" white O-M6-8IB-L-GwGw
- JL Audio MV400/4i - 4 channel amplifier
- JL Audio MV800/8i - 8 channel amplifier



## DECK LAYOUTS: AFT-CABIN PACKAGE

SX400GTO-P-012

SX400GTC-P-012

(Will replace standard toy storage in the aft)



## DECK LAYOUTS: AFT GLASS GATE

SX400GTO-O-009

SX400GTC-O-009



## DECK LAYOUTS: AFT GLASS WALL

SX400GTO-O-014

With opening door, window and access  
from stbd side  
(Standard in GTC)

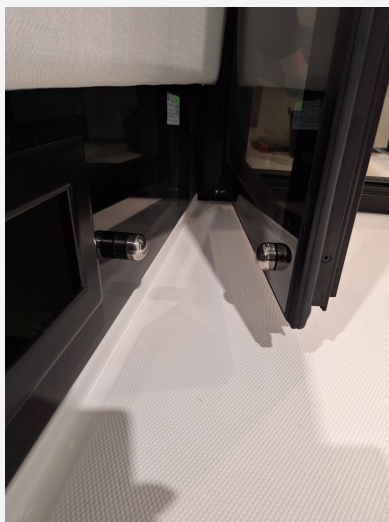

# DECK LAYOUTS: FLEXITEEK DECK AND WHEELHOUSE

SX400GTO-O-001

SX400GTC-O-001



## DECK LAYOUTS: ADDITIONAL CLEATS

SX400GTO-O-027

SX400GTC-O-027

Upgrade from fixed cleats on bathing platform to “pop-up” model and addition “pop-up” cleats mid-ship by a-pillar



# DECK LAYOUTS: UPGRADE TO "DIVERS STYLE" BATHING LADDER

SX400GTO-O-028

SX400GTC-O-028



# INTERIOR LAYOUT: UPGRADE OF MID-SHIP STORAGE TO SMALL SINGLE BERTH “KID- CABIN”

SX400GTO-P-009

SX400GTC-P-009

(Length 160cm)



# UPHOLSTERY OPTIONS: BOW SOFA CUSHION SET - INCLUDING COVERS

SX400GTO-O-010

SX400GTC-O-010



## EXTERIOR LAYOUT: TABLE IN BOW – INCLUDING TABLE COVER

SX400GTO-O-011

SX400GTC-O-011



## UPHOLSTERY OPTIONS: BOW SUNBED MATTRESS

SX400GTO-O-012

SX400GTC-O-012

(Table needs to be selected)



## INTERIOR LAYOUT: SECOND ROW SEATING

SX400GTO-O-019

SX400GTC-O-019

(Electrically operated for forward or  
backward seating)



# UPHOLSTERY OPTIONS: AFT SUNPAD MATTRESS ON TOP OF STANDARD TOY STORAGE/OPTIONAL AFT CABIN – INCLUDING COVERS

SX400GTO-O-005

SX400GTC-O-005



# UPHOLSTERY OPTIONS: INFILL CUSHION FOR WHEELHOUSE TABLE TO CREATE DAYBED

SX400GTO-O-025

SX400GTC-O-025



# CANOPY & SUNSHADES: CANOPY FOR GTO

SX400GTO-O-016

(to cover sides and aft of the wheelhouse)



# CANOPY & SUNSHADES: CANOPY FOR GTO WITH AFT GLASS WALL

SX400GTO-O-015

(to cover the sides of the wheelhouse)



# CANOPY & SUNSHADES: FRONS SUNSHADE FOR STATIONARY USE

SX400GTO-O-013

SX400GTC-O-013



# CANOPY & SUNSHADES: AFT SUNSHADE FOR STATIONARY USE

SX400GTO-O-008

SX400GTC-O-008



## COMFORT: ELECTRIC STOVE IN GALLEY EU - 240 VOLT

SX400GTO-P-004

SX400GTC-P-004

(Generator replacement package needed  
for off-grid use)



# COMFORT: BBQ PACKAGE EU - 240 VOLT

SX400GTO-P-005

SX400GTC-P-005

(Generator replacement package needed  
for off-grid use)

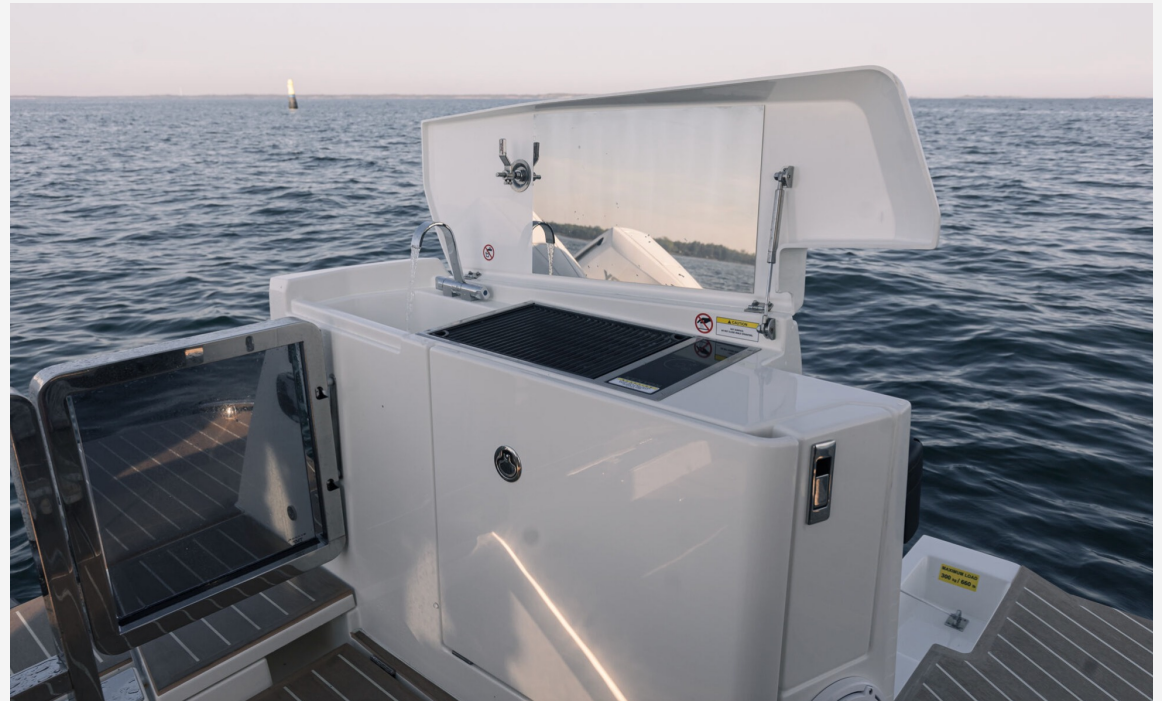

## COMFORT: ADDITIONAL REFRIGERATOR IN WHEELHOUSE

SX400GTO-O-024

SX400GTC-O-024

51 litres Drink model, no freezer box (cannot be combined with drawers on the side of helm seat box)



## COMFORT: DRAWER FRIDGE IN FRONT OF SEATS BOX 42 LITRES

SX400GTO-O-023

SX400GTC-O-023

(Cannot be combined with drawers in front  
of helm seat box)



## COMFORT: DRAWERS IN FRONT OF HELM SEAT BOX

SX400GTO-O-022

SX400GTC-O-022

(Cannot be combined with drawer fridge)



## COMFORT: DRAWERS ON THE SIDE OF HELM SEATS BOX

SX400GTO-O-021

SX400GTC-O-021

(Cannot be combined with additional  
fridge)



# COMFORT: CURTAINS IN FRONT CABIN

SX400GTO-O-017

SX400GTC-O-017



# DIMENSIONS:

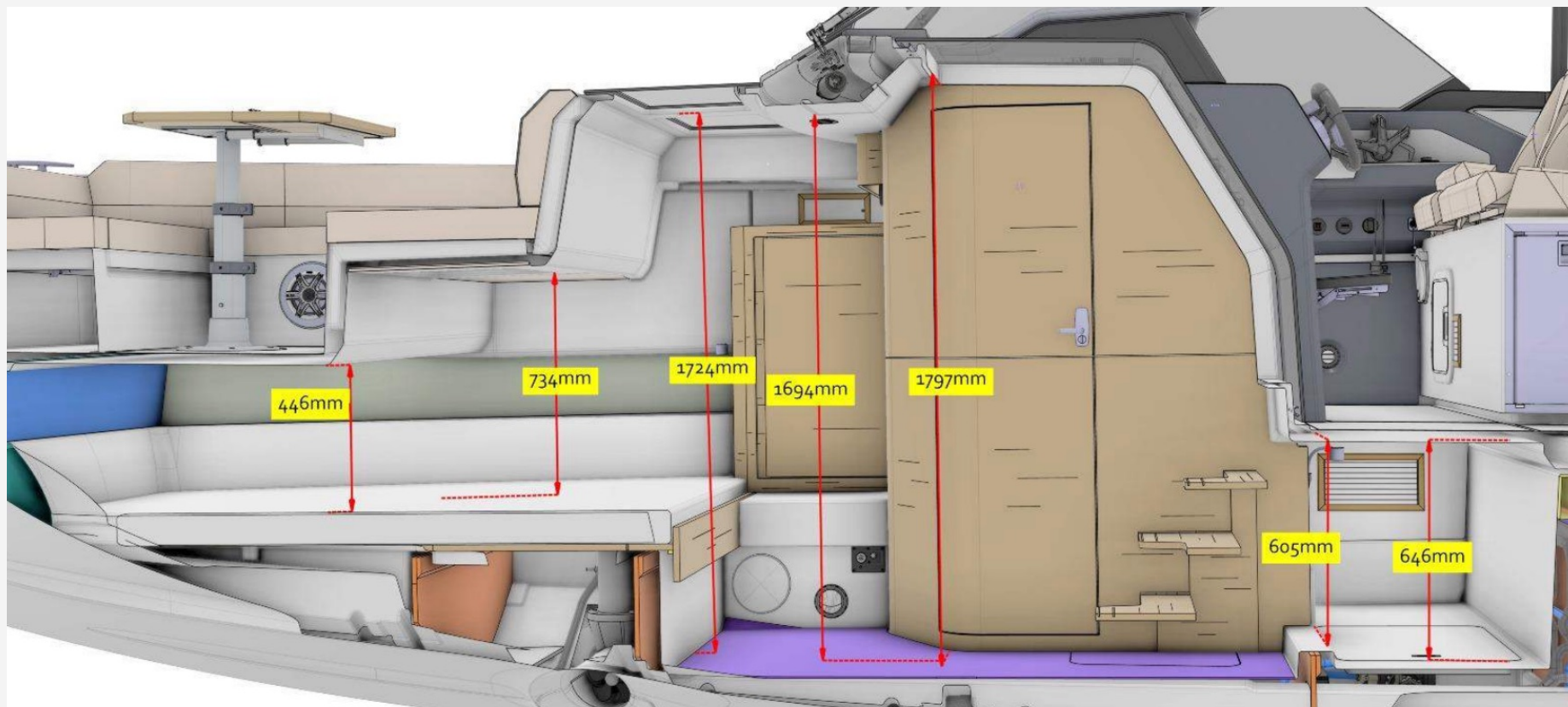

# DIMENSIONS:

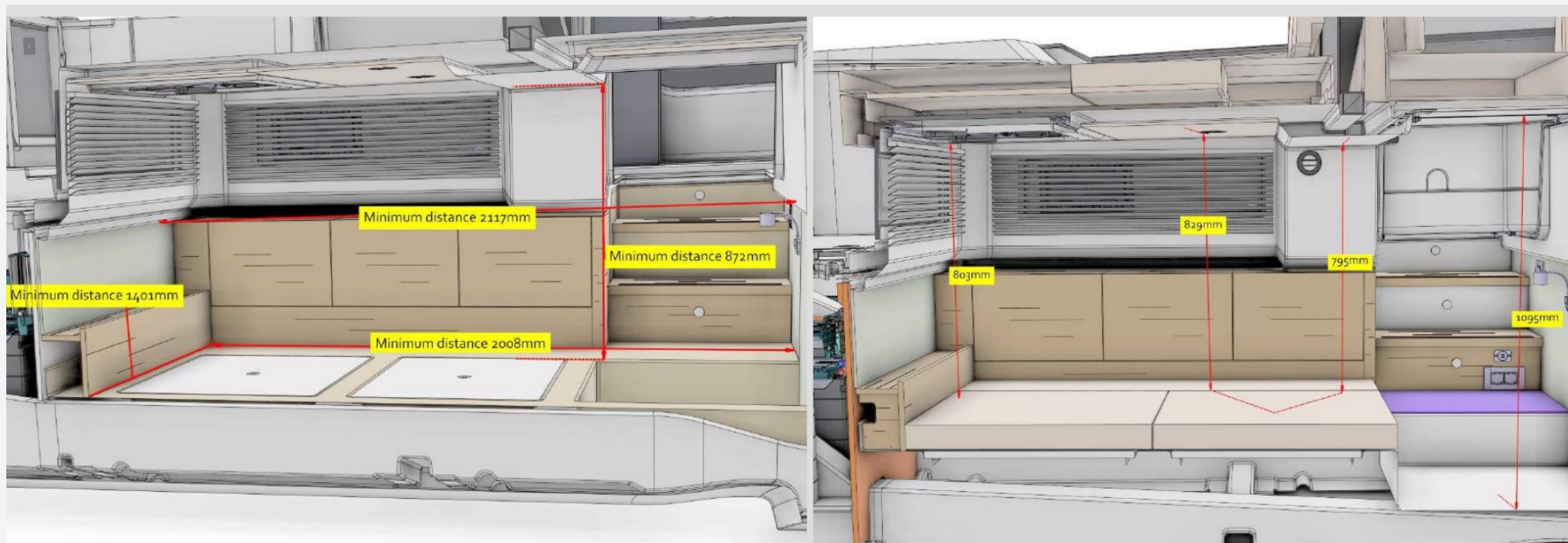

## DIMENSIONS:

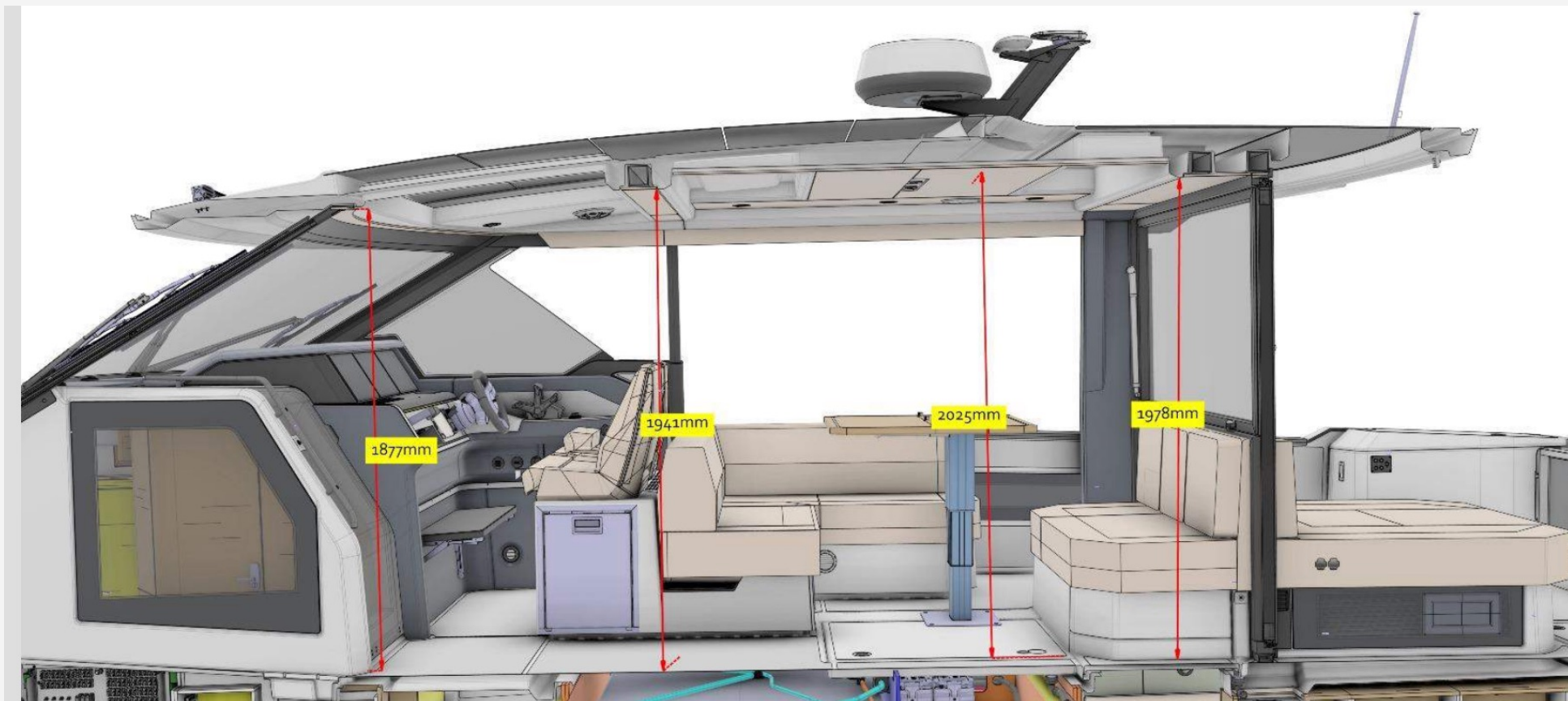

## DIMENSIONS:

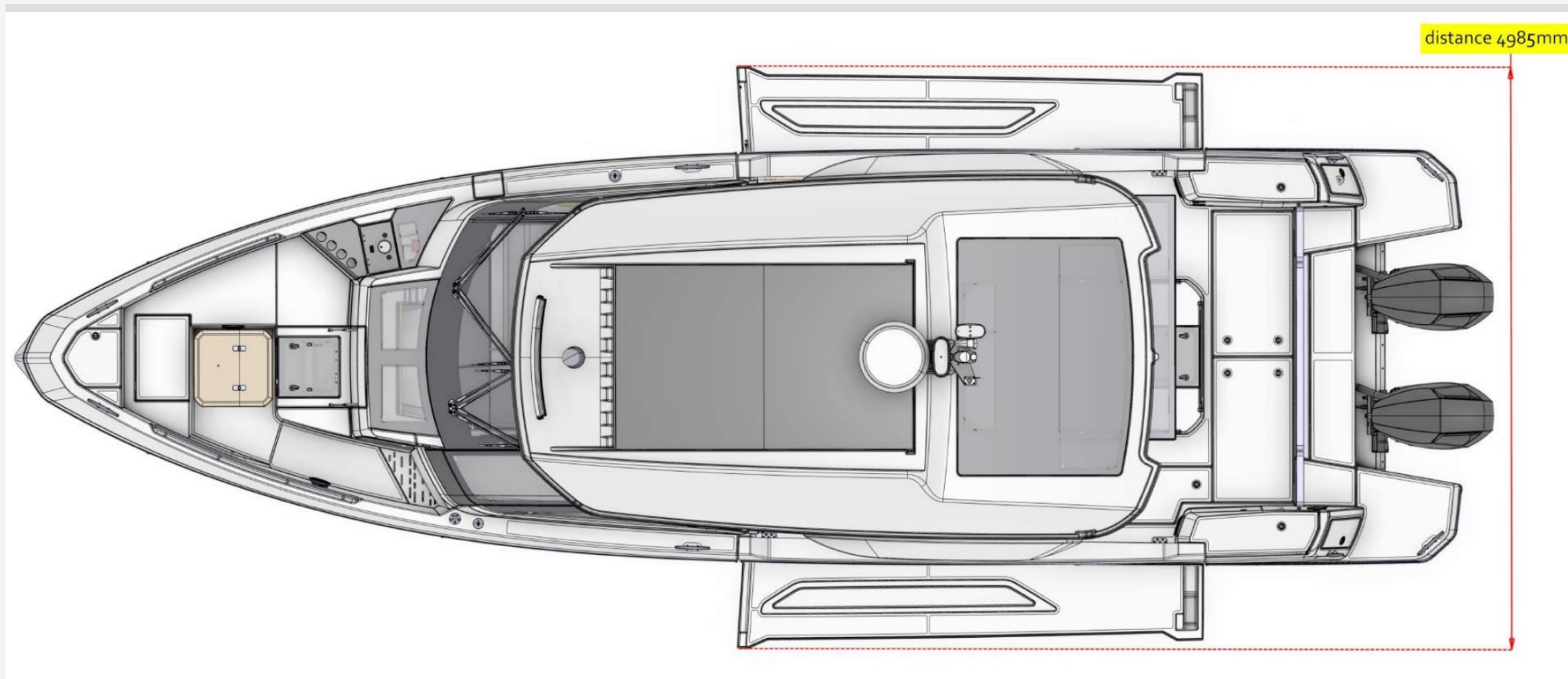

# DIMENSIONS:

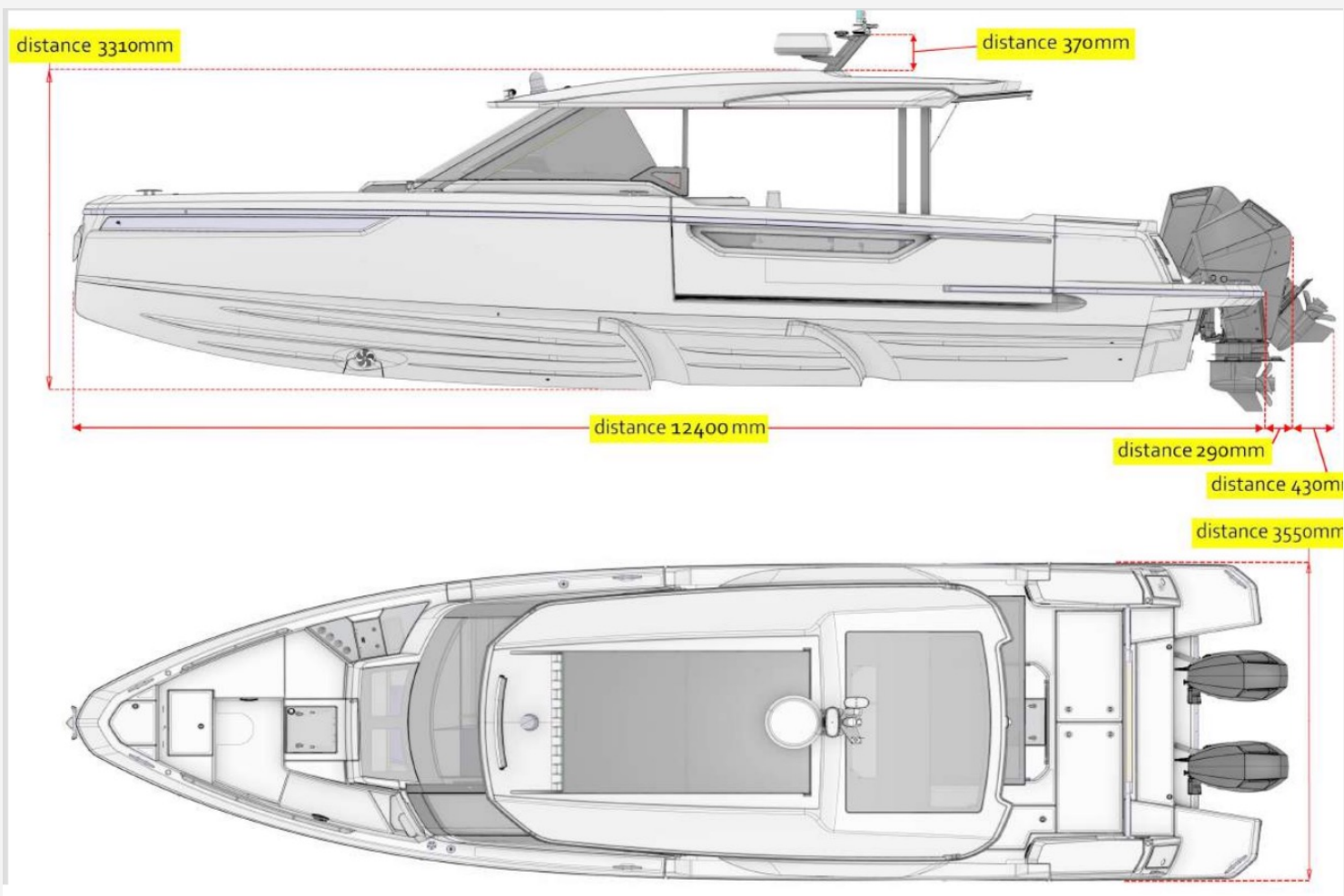

## DIMENSIONS:

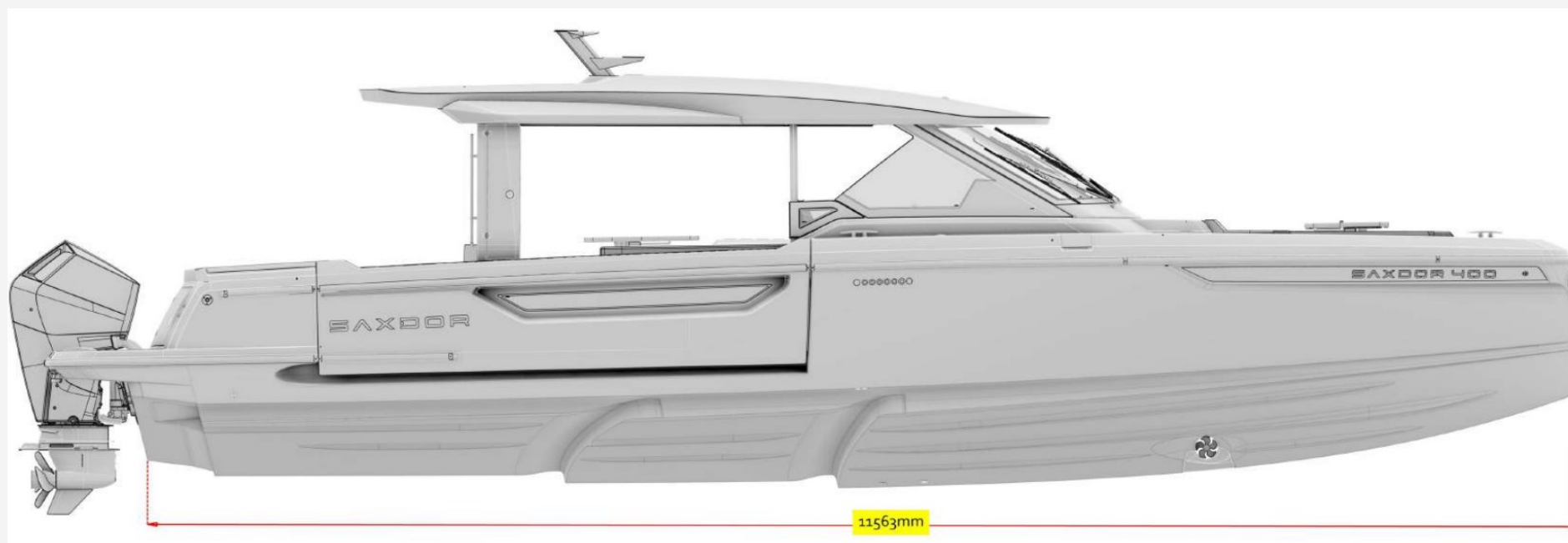

# DIMENSIONS:

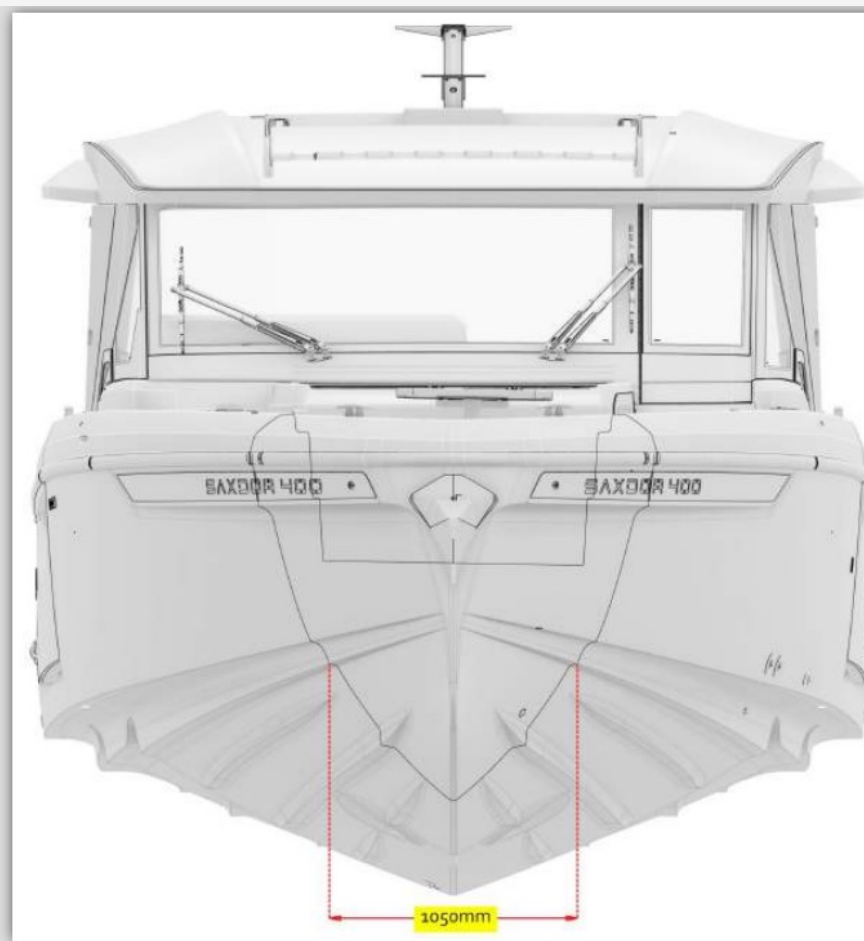
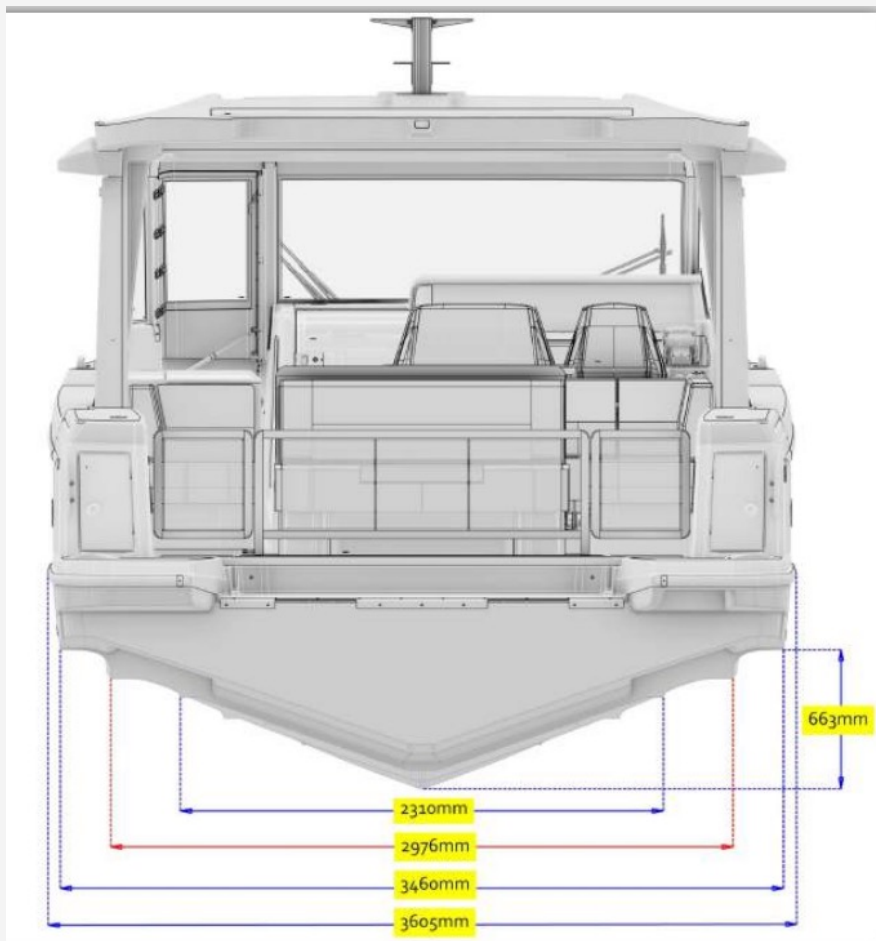

# DIMENSIONS:

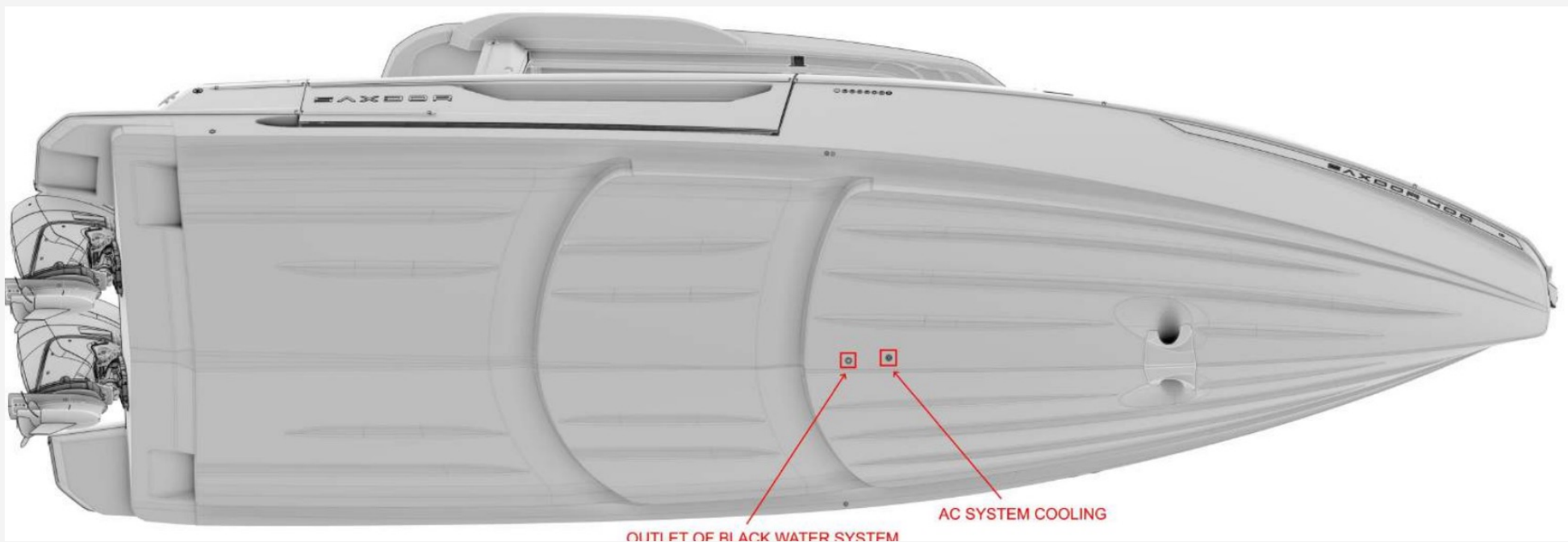

# DIMENSIONS:

Lifting points - OPTION 1  
Side view  
Scale 1:50

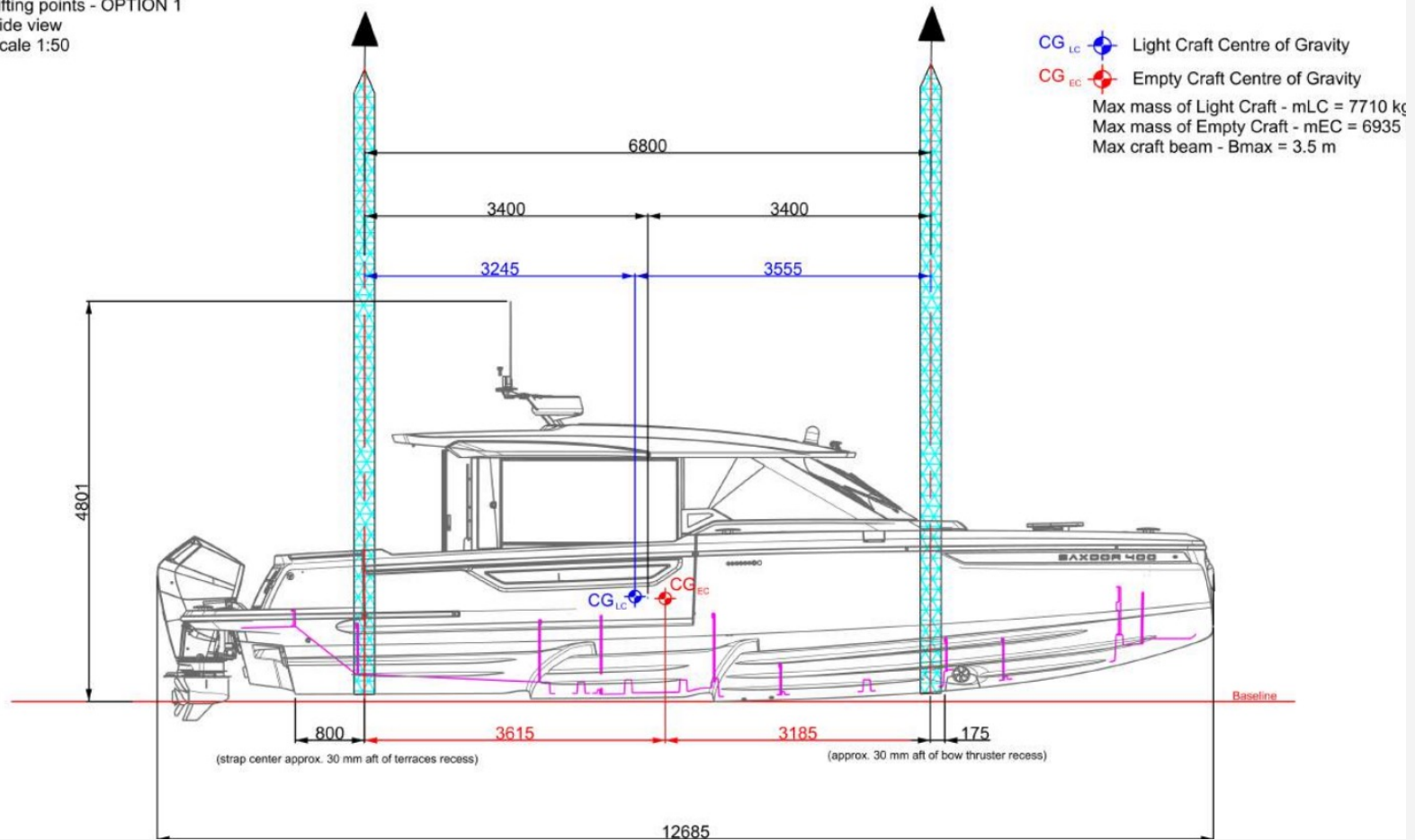

# DIMENSIONS:

Lifting points - OPTION 2  
 Side view  
 Scale 1:50

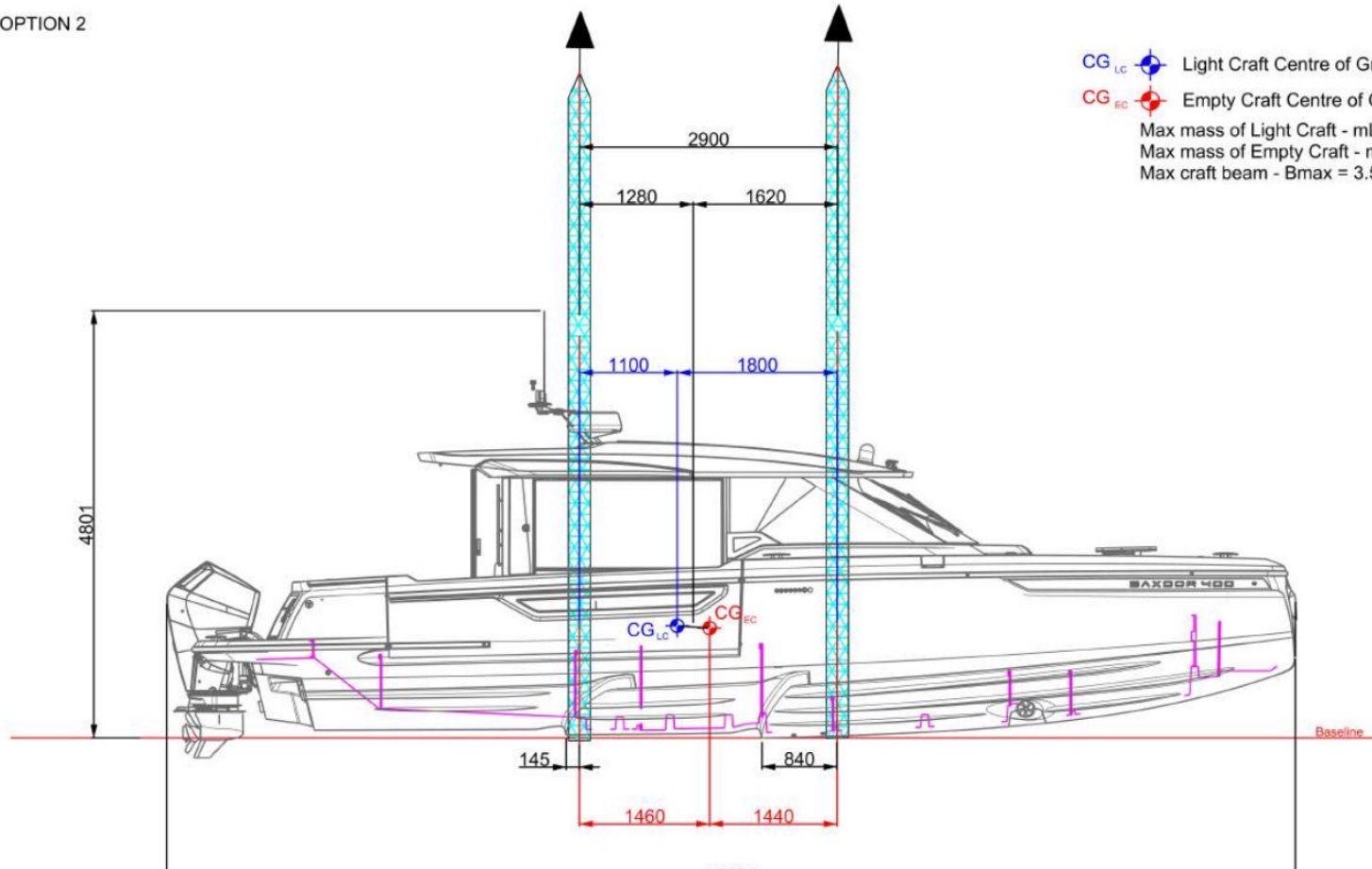

CG<sub>LC</sub> Light Craft Centre of Gravity  
 CG<sub>EC</sub> Empty Craft Centre of Gravity

Max mass of Light Craft - m<sub>LC</sub> = 7710 kg  
 Max mass of Empty Craft - m<sub>EC</sub> = 6935 kg  
 Max craft beam - B<sub>max</sub> = 3.5 m

# DIMENSIONS:

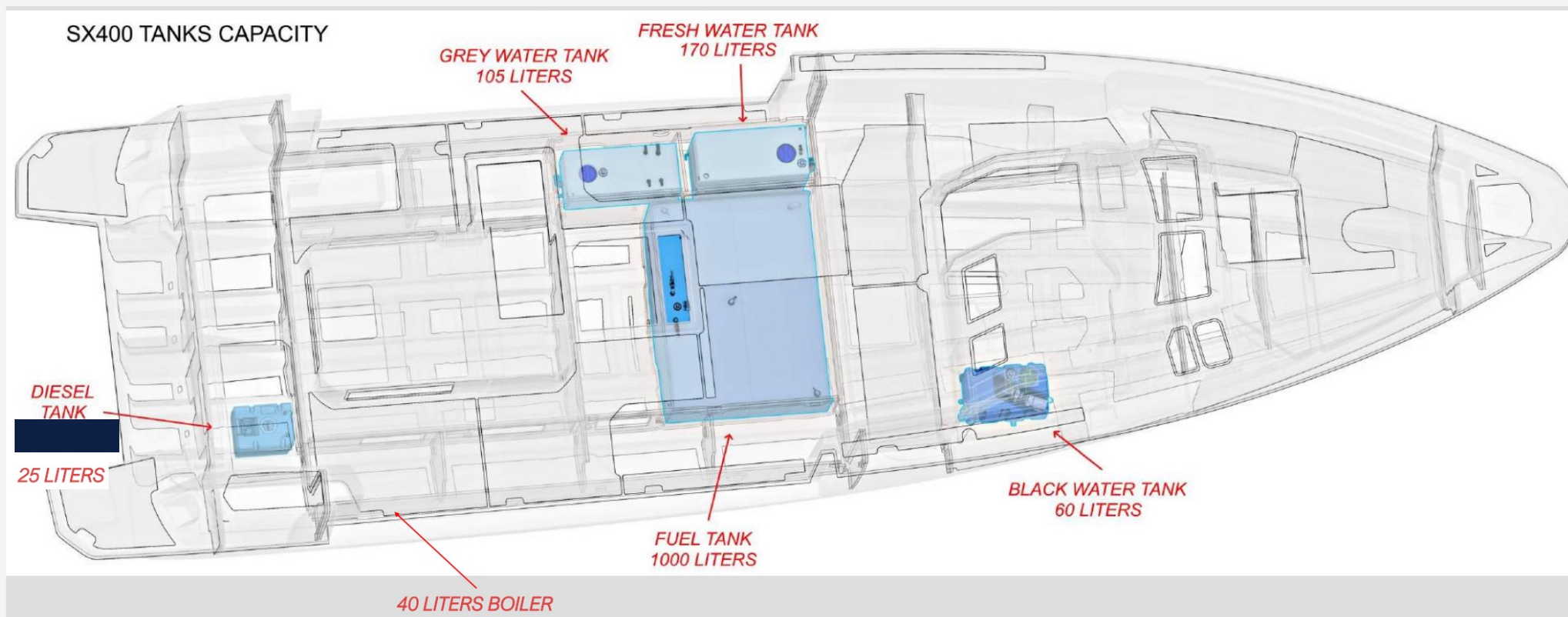

# TECHNICAL DETAILS: 400GTC AC SYSTEM

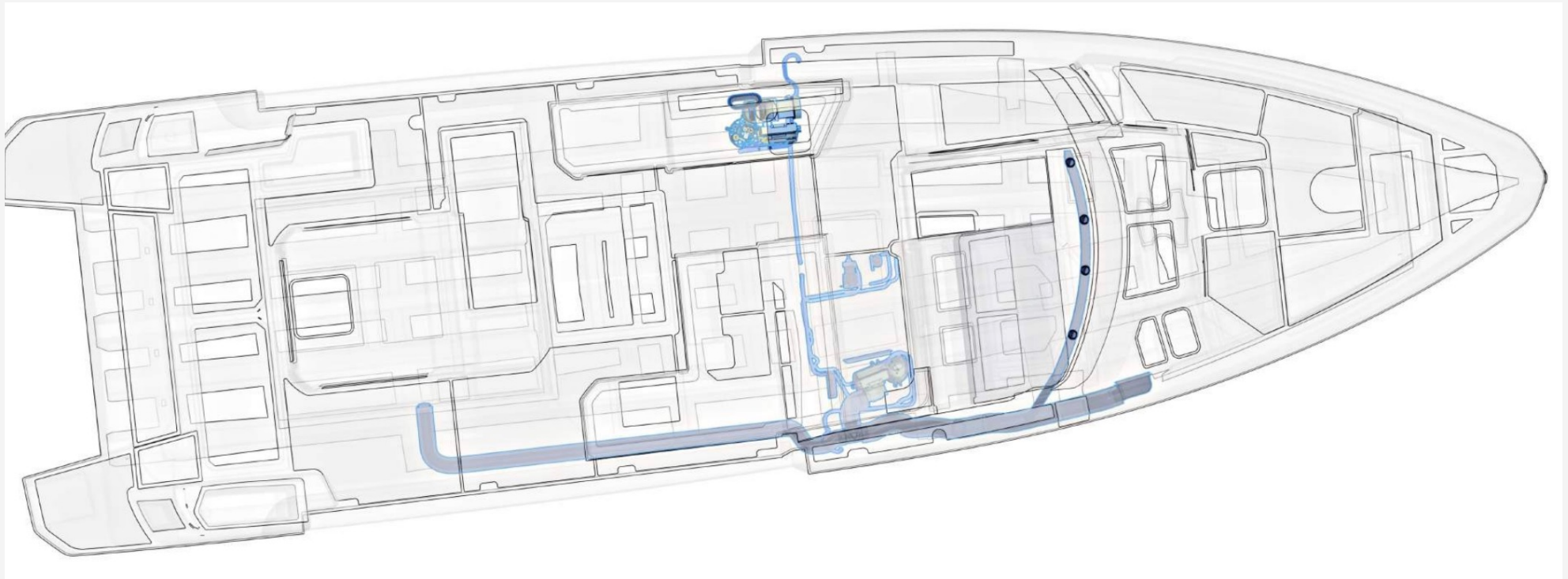

## TECHNICAL DETAILS: 400GTO AC SYSTEM

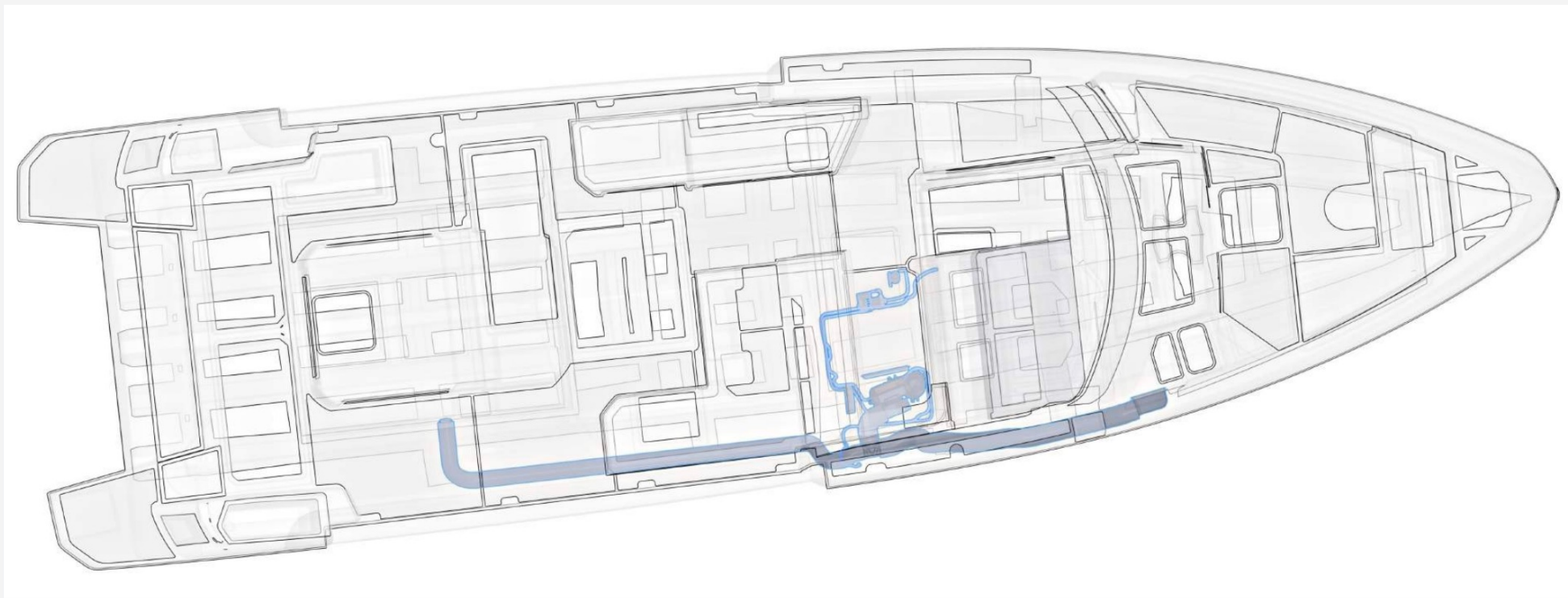

# TECHNICAL DETAILS: 400 HEATING SYSTEM

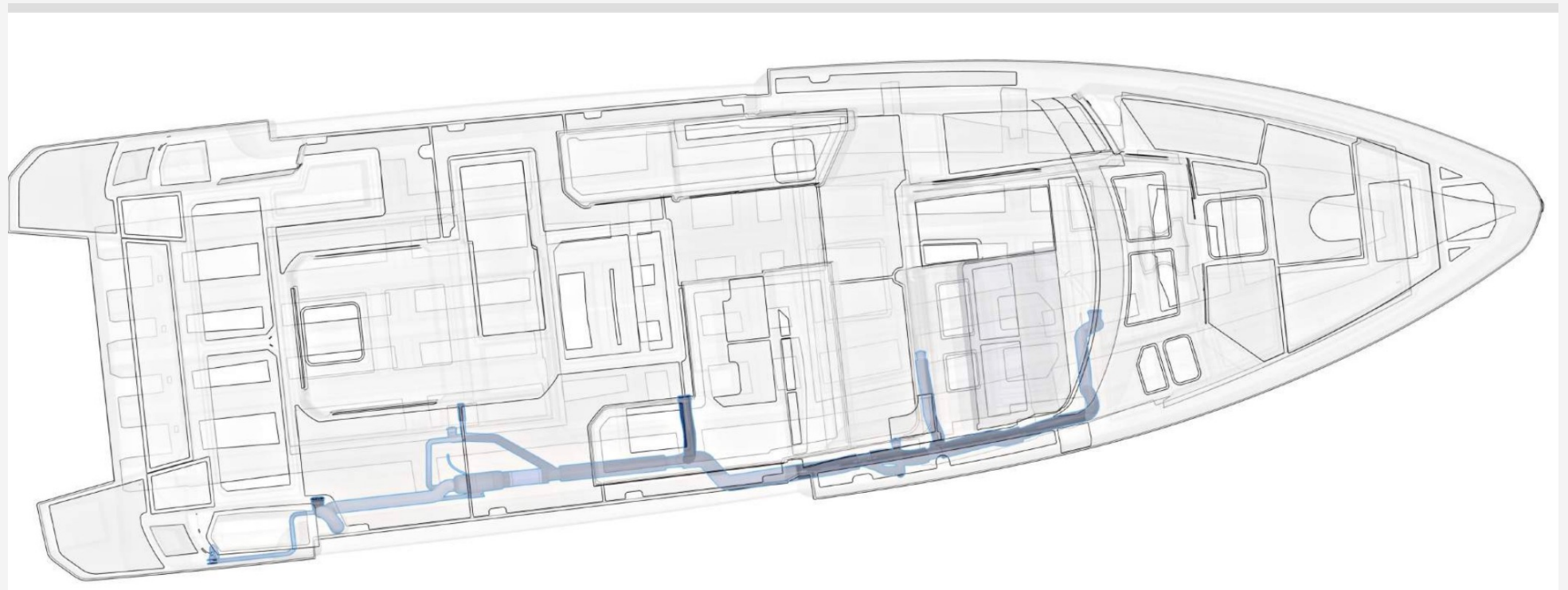

## SUMMARY GTO/GTC:

- Cruising speed: 28-35 knots
- 700-800 HP
- 12 persons (cat. B)
- Length: 12.4 metres
- Weight: 7500 kg / 7800 kg (with engines)
- Fuel capacity: 1000 L

